

PowerVision S1

User Manual

V1.0

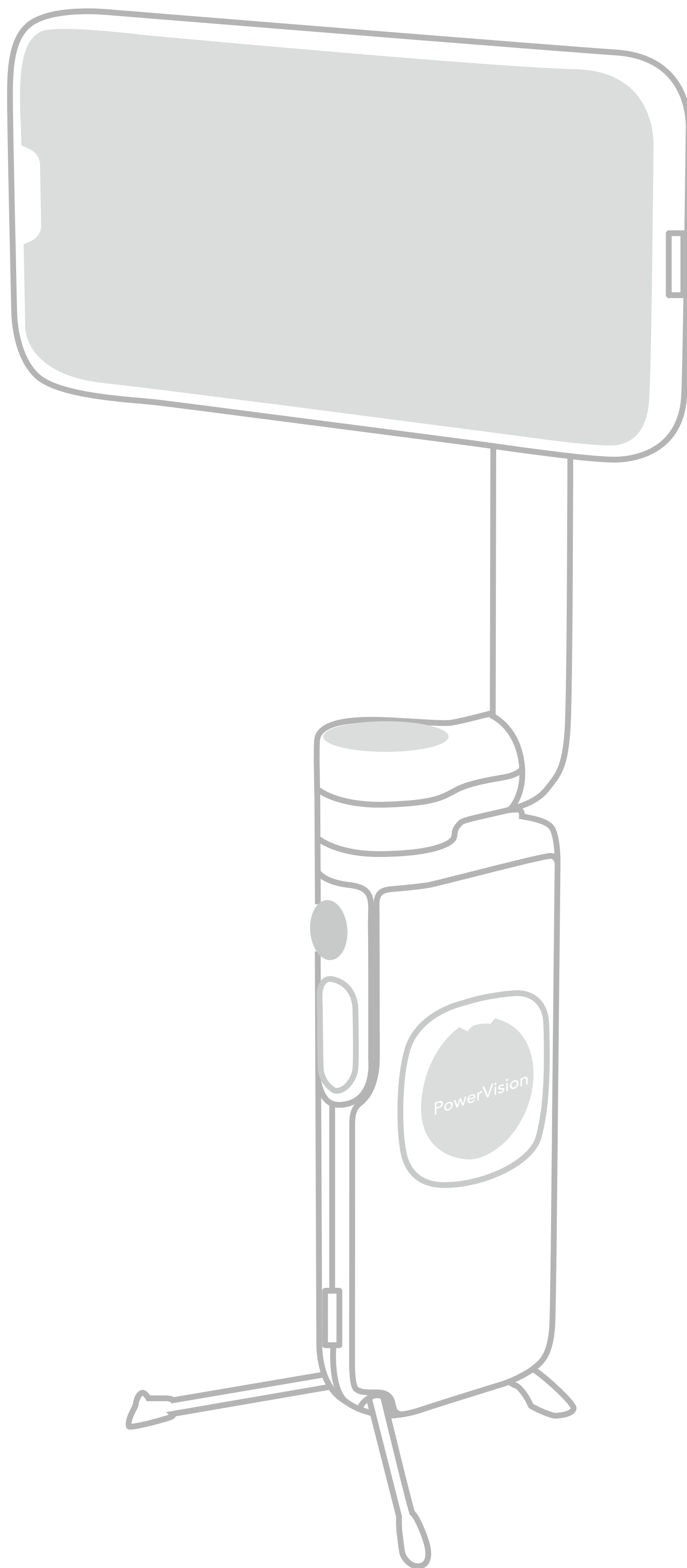

PowerVision

Contents

Reading suggestion	1
Symbol description.....	1
Usage recommendations.....	1
Tutorial Video.....	1
Product description	2
About PowerVision S1.....	2
Buttons and port functions.....	4
Unfolding and storage.....	7
Charging.....	12
Phone installation and balance adjustment.....	12
Preparing for use	15
Connecting PowerVision S1.....	16
Activating PowerVision S1.....	16
Using the gimbal	17
Operating modes	17
Shooting with Vision+S1.....	18
Using PowerFollow mode.....	20
Charging your phone with S1	22
Charging your phone wirelessly.....	22
Functions as a wireless charger for phones.....	22
Charging your phone with a wired charger.....	23
Firmware upgrade	24
Specifications	25

Reading suggestion

Symbol description

 Precautions

Usage recommendations

PowerVision S1 provides users the following information:

1. "Tutorial Video"
2. "Disclaimer and Safety Guidelines"
3. "Quick Start Guide"
4. "User Manual"

We recommend that users watch the tutorial video for this product on the official PowerVision website <https://www.powervision.me> or Vision+S1 App before using this product.

To learn more about how to use this product, read the "Disclaimer and Safety Guidelines" and "Quick Start Guide".

For detailed product operating instructions, read this user manual.

Watch Tutorial Video

Download Vision+S1 App in your phone's App store. Search for Vision+S1 App or scan the following QR code with your phone:



To ensure optimal performance of Vision+S1 App, make sure that your device is using iOS version 12.0 or Android version 7.0 or higher.

App tutorial video location:

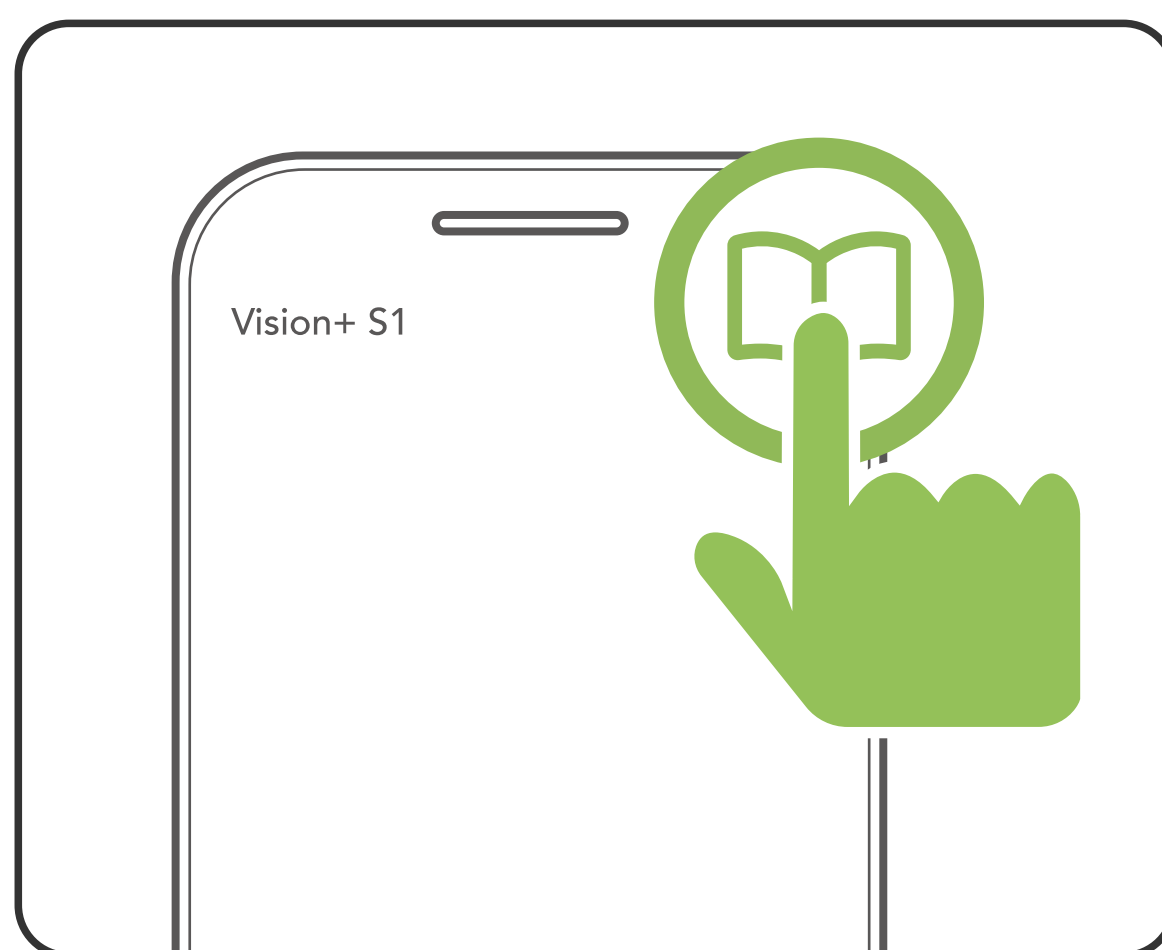

Official website tutorial video location:

<https://www.powervision.me/app/3.0/powervisions1.html>

Product description

PowerVision S1 combines a three-axis stabilized handheld gimbal, smart stand, and wired and wireless charging in a single device. Its clever and compact folding design is elegant and easy to carry, making it the perfect companion for smartphones.

PowerVision S1 integrates three-axis gimbal with high precision, which features physical stabilization that helps phones capture smoother and less-shaky motion pictures. The device folds into a small size that's convenient to carry and easy to store. Users can also use S1 to fast charge their phones with a wired or wireless charger any time and anywhere.

Use Bluetooth to connect to Vision+S1 App and control your phone using the gimbal's buttons. Shooting in special effect modes such as Panorama, Motionlapse, and Slowmotion is supported.

PowerVision S1 is the first product of its kind to feature a PowerFollow function. PowerFollow enables the gimbal to automatically follow your movement during live-streaming, improving the quality of indoor and outdoor shooting of motion scenarios.

About PowerVision S1

- PowerVision S1 part names

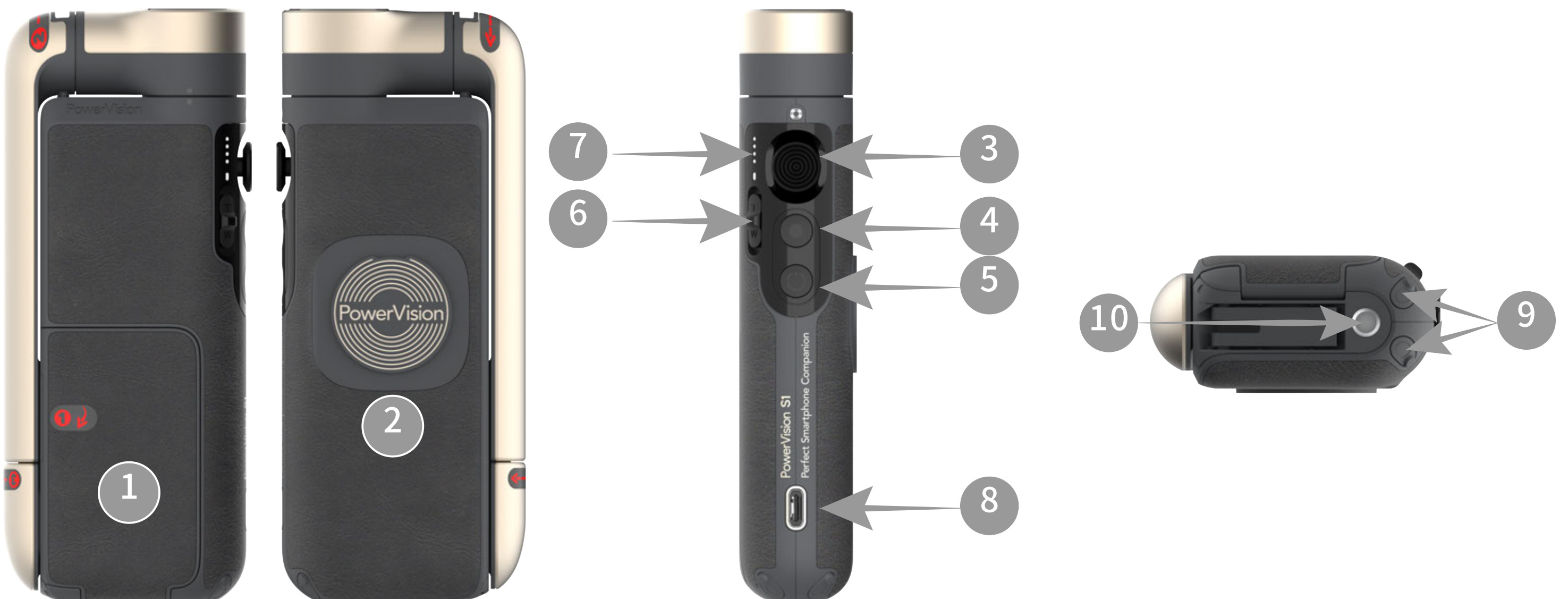

1. Motor Cover

2. Wireless Charging Output

3. 5-Way Button

4. Camera Button

5. Power Button

6. Zoom Slider

7. System Status Indicator

Battery Level Indicator

8. USB-C Port

9. Built-in Tripod

10. 1/4"-20 UNC Port

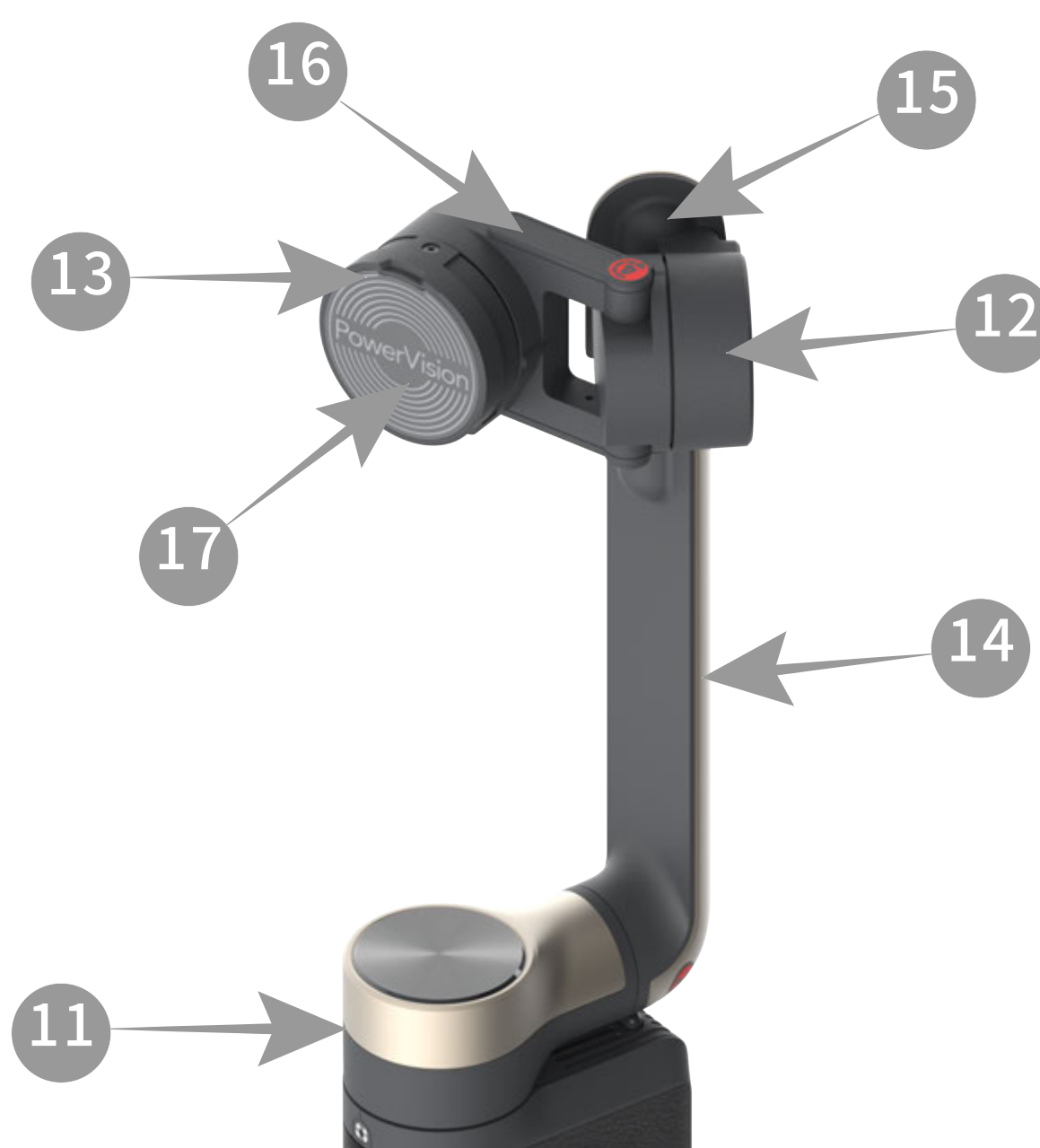

11.Pan Motor

14.Main Arm

17.Magnetic Mounting Plate

12.Tilt Motor

15.Tilt Joint

13.Roll Motor

16.Roll Joint

- Magnetic Phone Clamp



- Magnetic Phone Case (sold separately)

1.Magnetic Mounting Plate

2.Slide Stand

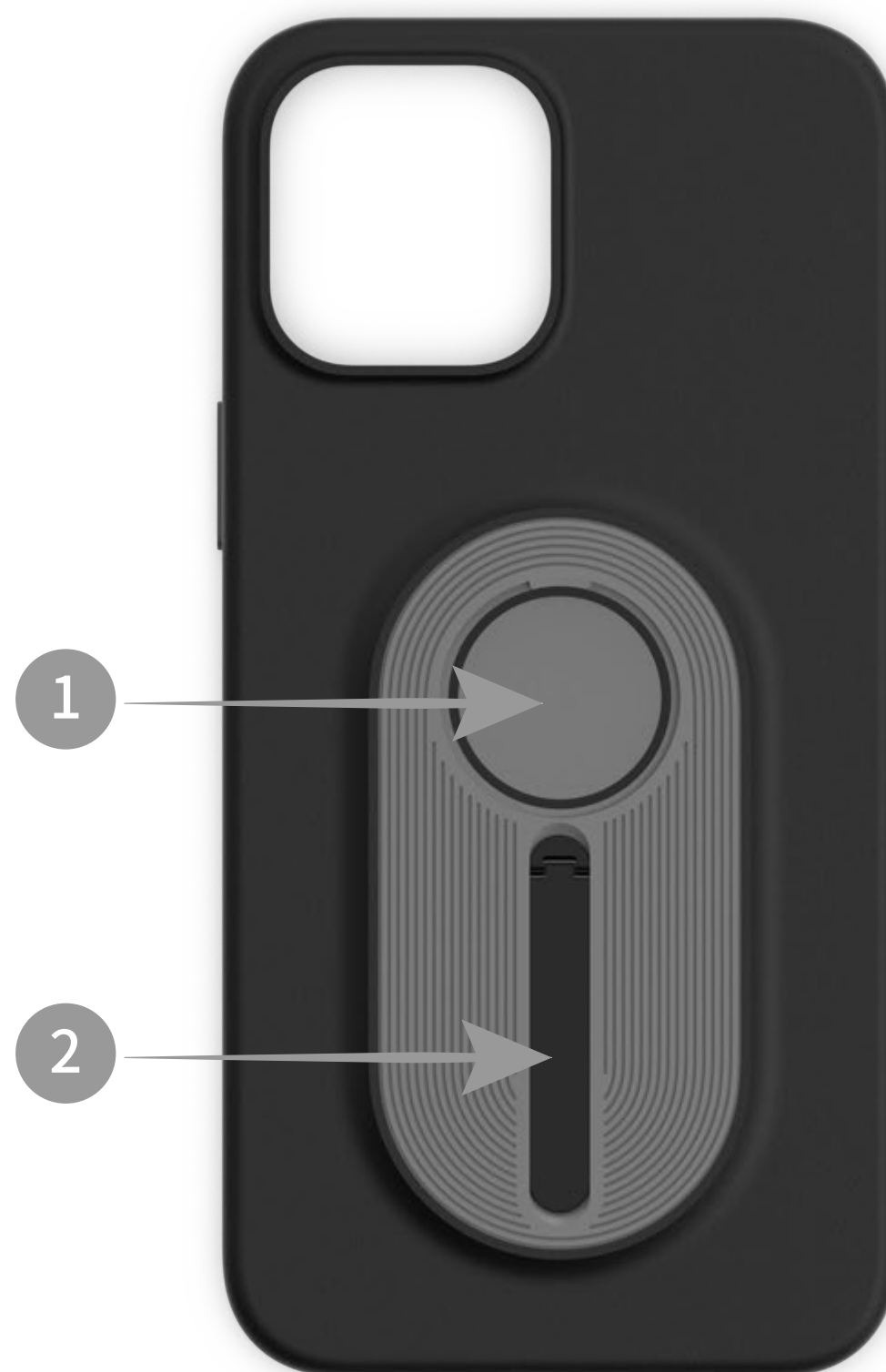

- Magnetic Universal Phone Mount (sold separately)

1.Magnetic Universal Phone Mount (sold separately)

2.Slide Stand

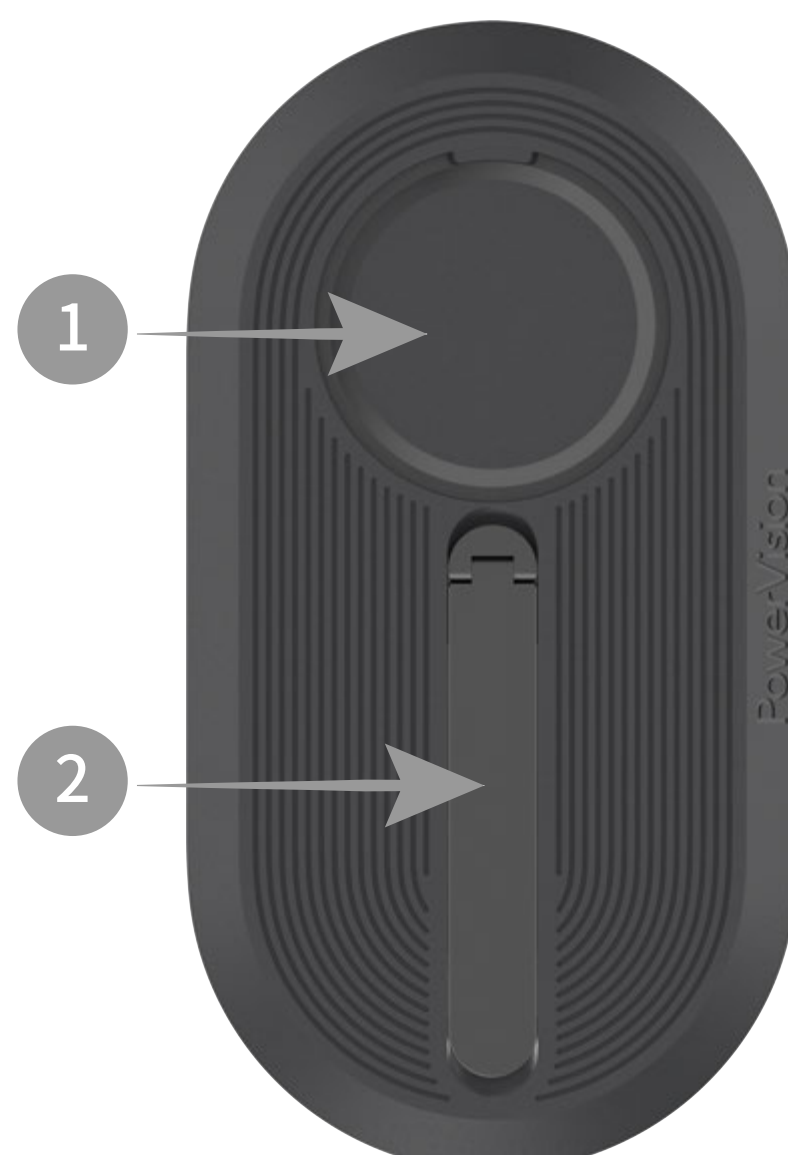

Buttons and port functions

By default, PowerVision S1 is in Follow mode when it is powered on. In Follow mode, the gimbal will keep the phone level at all times during shooting. When the gimbal is moved up, down, left, or right, the shooting direction will be adjusted smoothly.

Use the following buttons and ports to access PowerVision S1's functions:

◆ Power Button



OFF mode

- Press once: View battery level and activate charger mode.
- Press and hold: Turn on.

ON mode

- Press once: Open the shortcut menu, and press again to return to camera mode.
- Press twice: Toggle between portrait and landscape mode.
- Press three times: Enter playback mode, and press again to return to camera mode.
- Press and hold: Power off.

Standby mode

- Press once: Wake up device.

◆ Camera Button

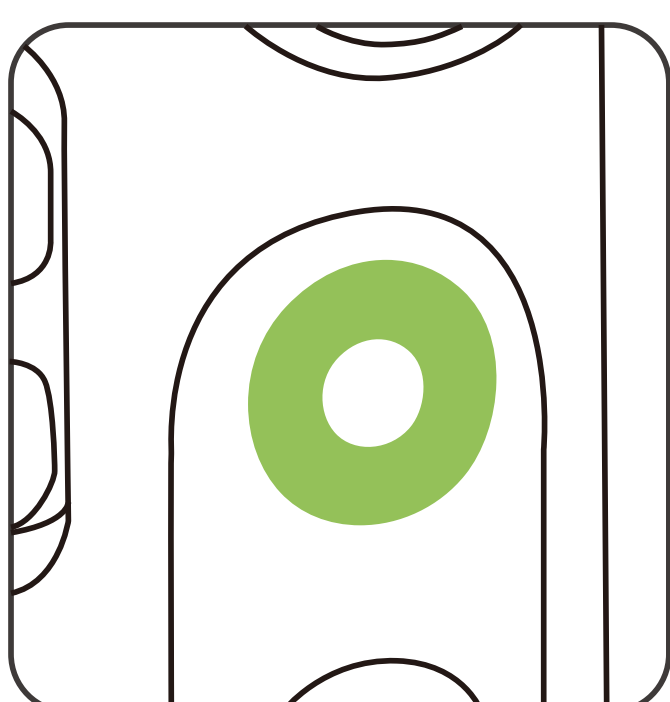

ON mode

- Press once: Photo or video.
- Press and hold: Burst shooting when in photo mode.

Standby mode

- Press once: Wake up device.

◆ System Status Indicator

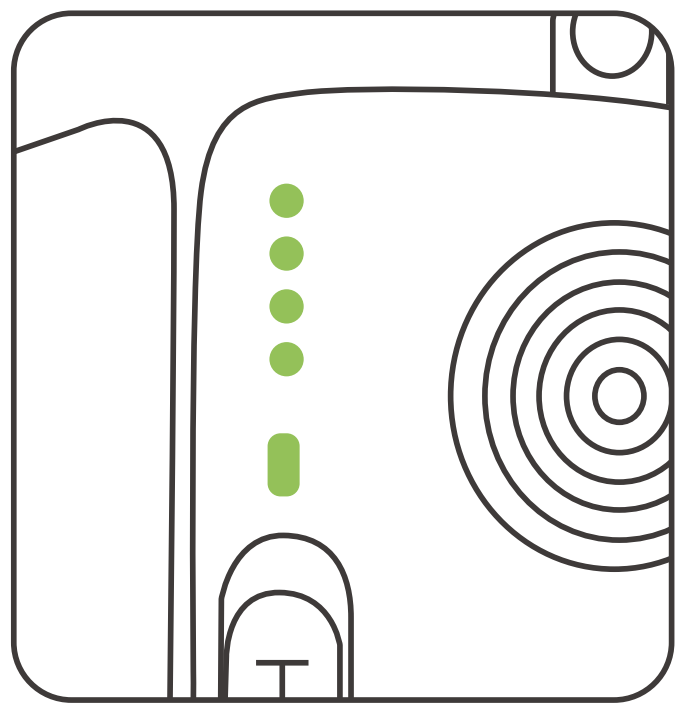

Indicates the current system status

Blinking pattern	Indicator status
Solid yellow light	Bluetooth not connected
Solid green light	Bluetooth connected
Yellow and green pulses blink	Standby mode
Solid orange light	Phone charger mode
Blinking blue light	Gimbal is updating
Blinking red light	Gimbal exception (too high or too low temperature, excessive battery discharge etc.)

◆ Battery Level Indicator

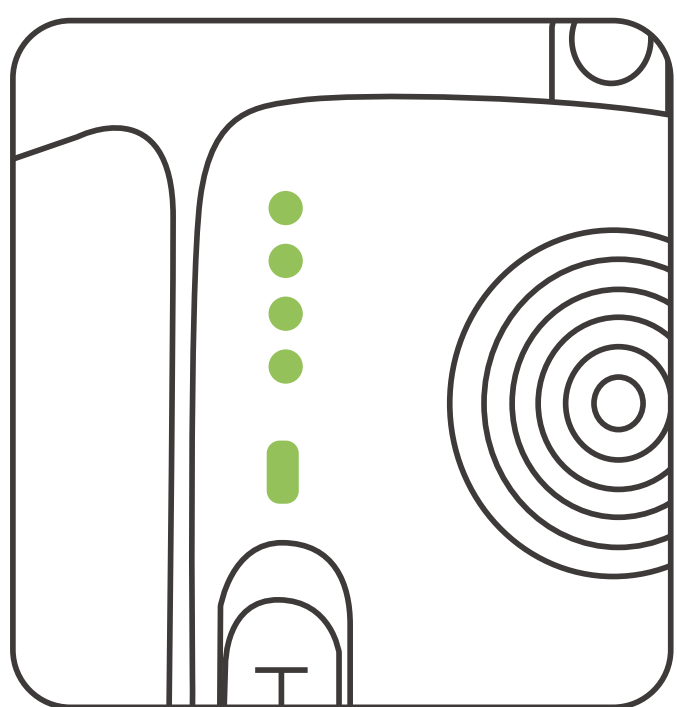

Operating status:

Current battery level	LED1	LED2	LED3	LED4
0%~13%	☀	○	○	○
13%~25%	●	○	○	○
25%~38%	●	☀	○	○
38%~50%	●	●	○	○
50%~63%	●	●	☀	○
63%~75%	●	●	●	○
75%~88%	●	●	●	☀
88%~100%	●	●	●	●

Charging mode:

Battery level	LED1	LED2	LED3	LED4
0%-50%	☀	☀	○	○
50%-80%	☀	☀	☀	○
80%-100%	☀	☀	☀	☀
Fully charged	○	○	○	○

◆ 5-Way Button

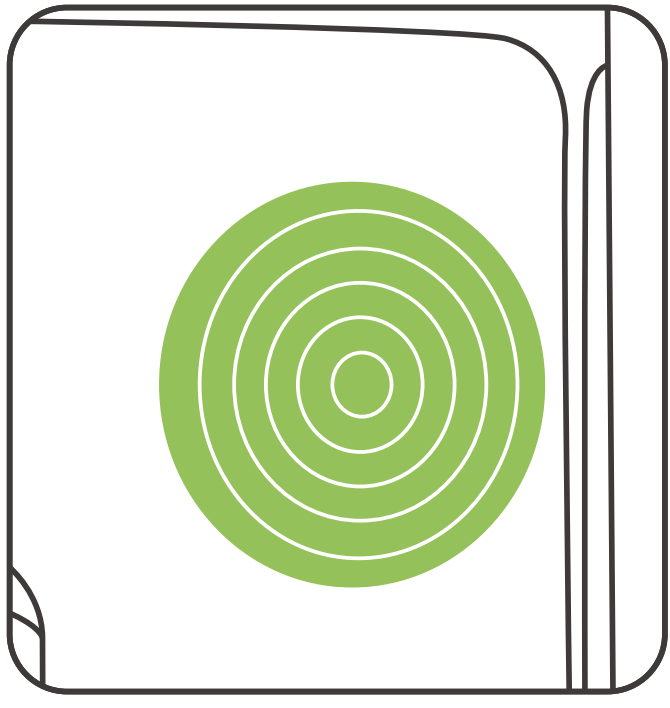

Camera mode:

Up, down, left, and right buttons: move the gimbal in four directions

Middle button:

- Press once to enable Tracking mode. Press once again to disable Tracking mode.
- Press twice to re-center the gimbal.
- Press three times to switch between front and rear cameras.
- Press and hold firmly to enter Lock mode.
- Press once and then hold firmly to enter Sport mode. Release to turn off Sport mode.

Standby mode:

- Press once to wake up device.

◆ Zoom Slider

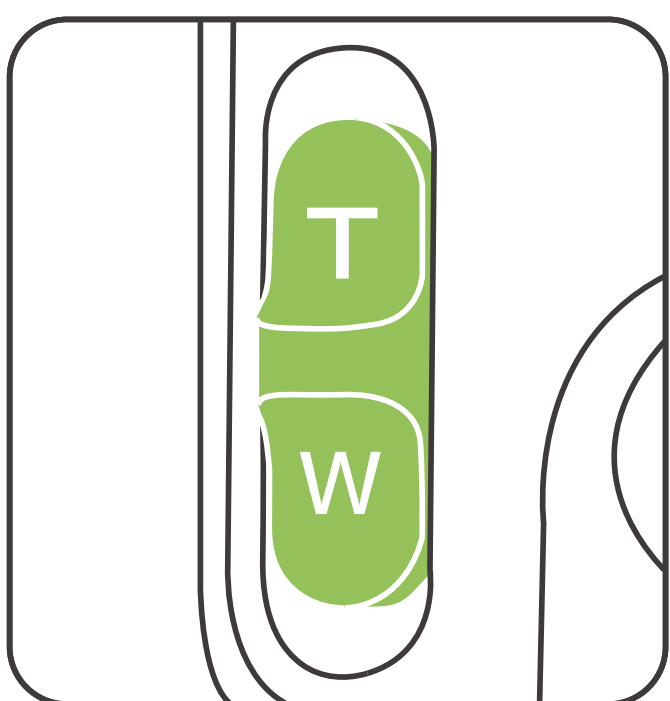

Camera mode: Slide up or down to control the camera zoom.

- Press once to increase/decrease the camera zoom factor.
- Press to continuously increase/decrease the camera zoom factor.

◆ USB-C Port

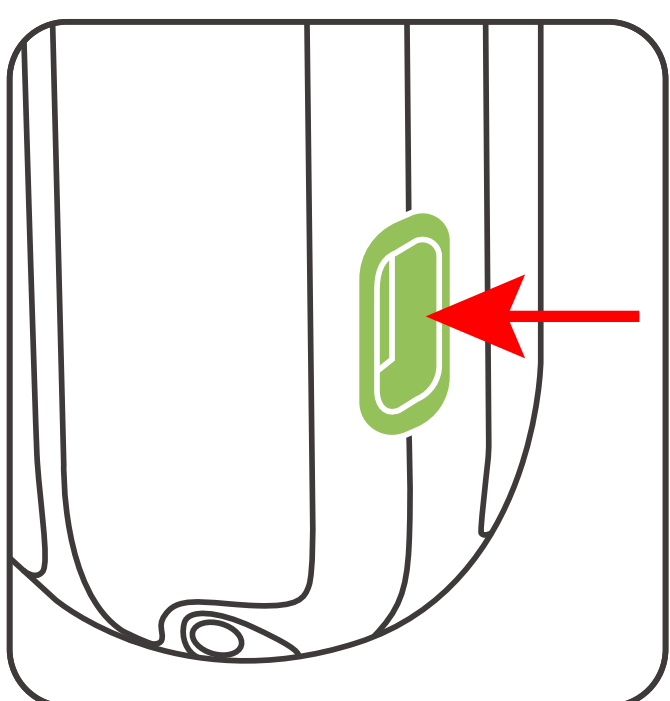

Charging port

- Use this port to connect to the USB charger, and charge PowerVision S1 .

Power supply port

- Use this port to connect and charge your phone.

◆ Built-in Tripod

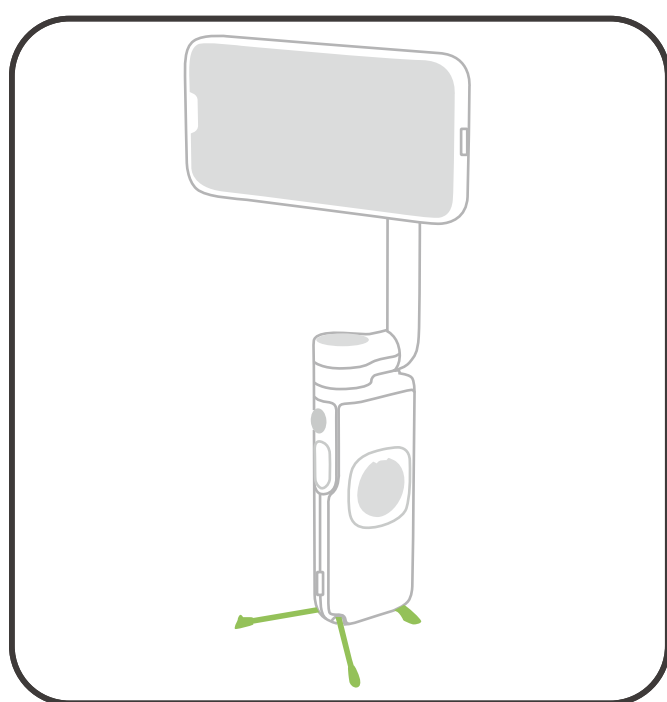

PowerVision S1 features a built-in tripod. Extend and unfold the tripod to place it on a stable table.

◆ 1/4"-20 UNC Port

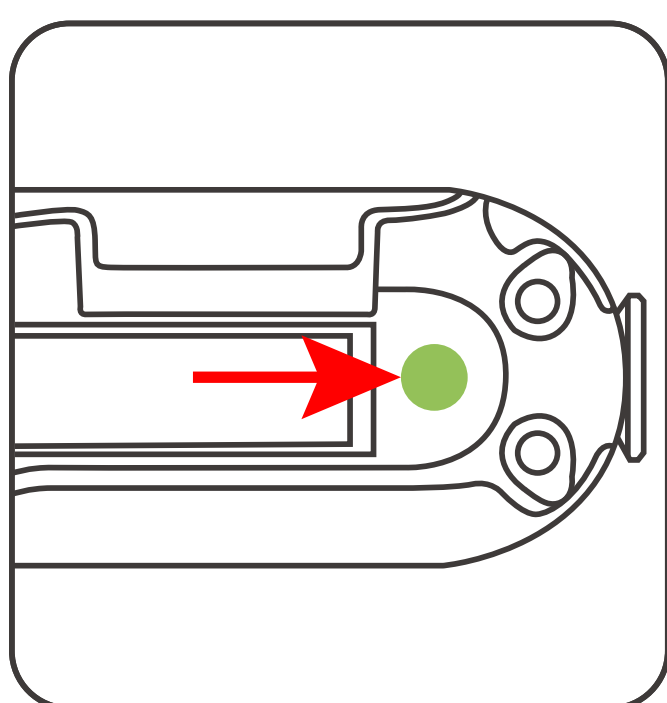

Use the 1/4"-20 UNC Port located at the base to connect the gimbal to an external tripod.

I Unfolding and storage

PowerVision S1 was designed to be extremely portable. The device can be folded into a small size, making it easy to store and transport, and can also be used to charge phones.

◆ Unfolding



Do not turn on S1 when it is in storage. Please install the phone onto the gimbal before turning it on and using the device.

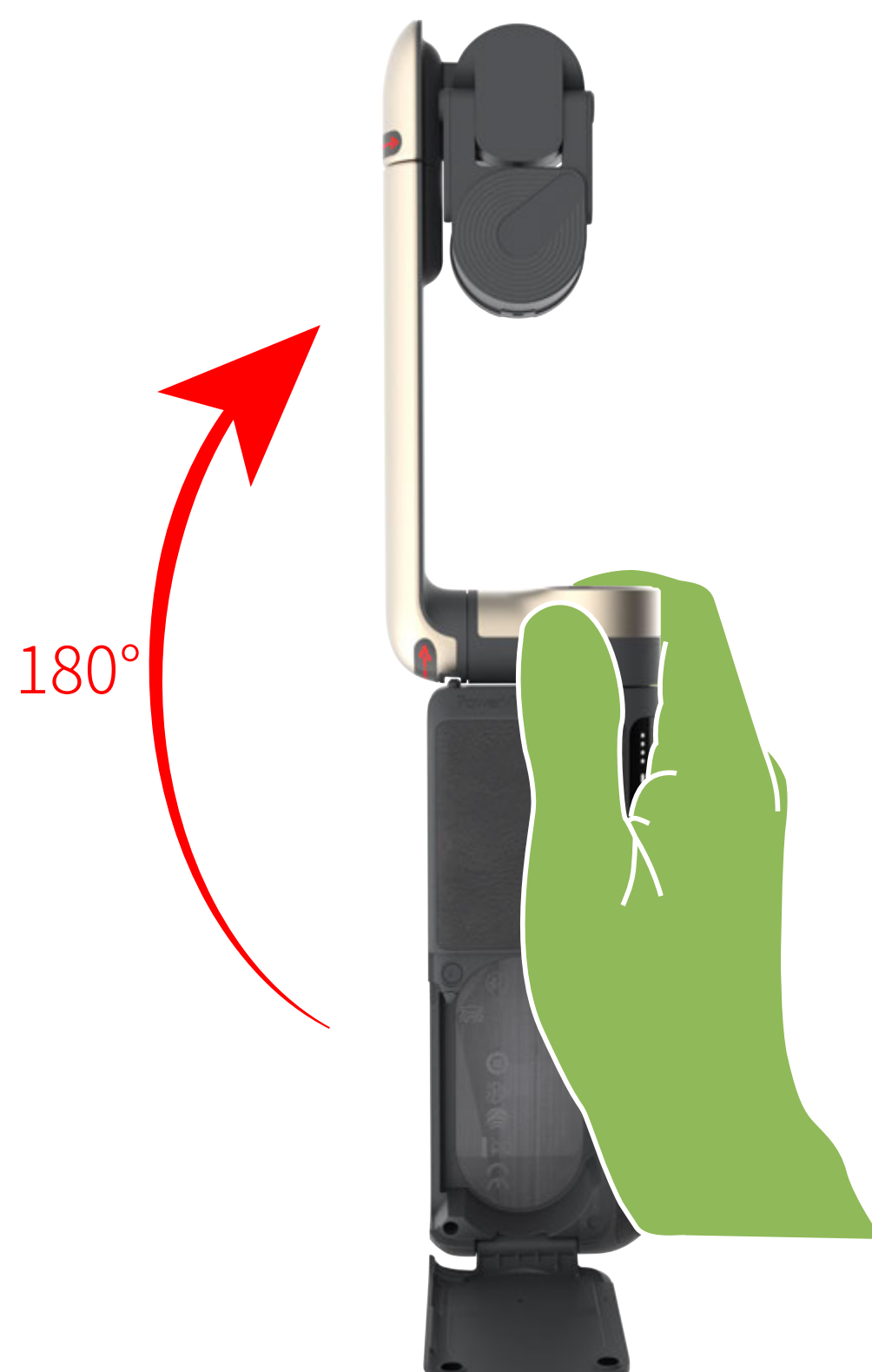

Open the [Motor cover], and rotate the [Main arm] 180 degrees vertically until level with the device.



Rotate the [Roll joint] to the illustrated position.



Hold the main arm and rotate the [Tilt joint] counterclockwise to the illustrated position.



Use a ①magnetic phone clamp, ②magnetic phone case, or ③magnetic universal phone mount to install your phone into the gimbal and start using it.

◆ Storage



Please remove your phone and power off S1 before storing it



Hold the main arm and rotate the [Tilt joint] clockwise to the illustrated position.



Rotate the [Roll joint] to the illustrated position.



Open the [Motor cover], and rotate the [Main arm] 180 degrees vertically into the device.



Close the [Motor cover] to finish storage.

◆ Unfolding and storing built-in tripod of S1



Completely extend S1's built-in metal feet at the base of the device.



Fold the metal feet into the illustrated position.



Open the Card Foot at the base.



Place the device on a level surface.

Charging

Use the USB charging cable (provided) and a compatible power adapter (sold separately) to connect to PowerVision S1's USB-C port and charge the device.

When the device is fully charged while in OFF mode, the battery level indicator will automatically turn off.



This product supports fast charging, and is recommended to be paired with third party adapters that have a power output of at least 18 W.

Charging time: about 2 hrs (*tested on an 18 W charger)

Max operating time: 15 hrs. (*Under ideal conditions with the gimbal fully balanced).

Phone installation and balance adjustment

PowerVision S1 supports connecting your phone to the gimbal and quick dismantling via a variety of accessories, including the magnetic phone clamp, magnetic phone case, or magnetic universal phone mount.

◆ Magnetic phone clamp

1. Place the magnetic phone clamp in the middle of the phone, with the camera logo on the side facing the direction of the phone's camera

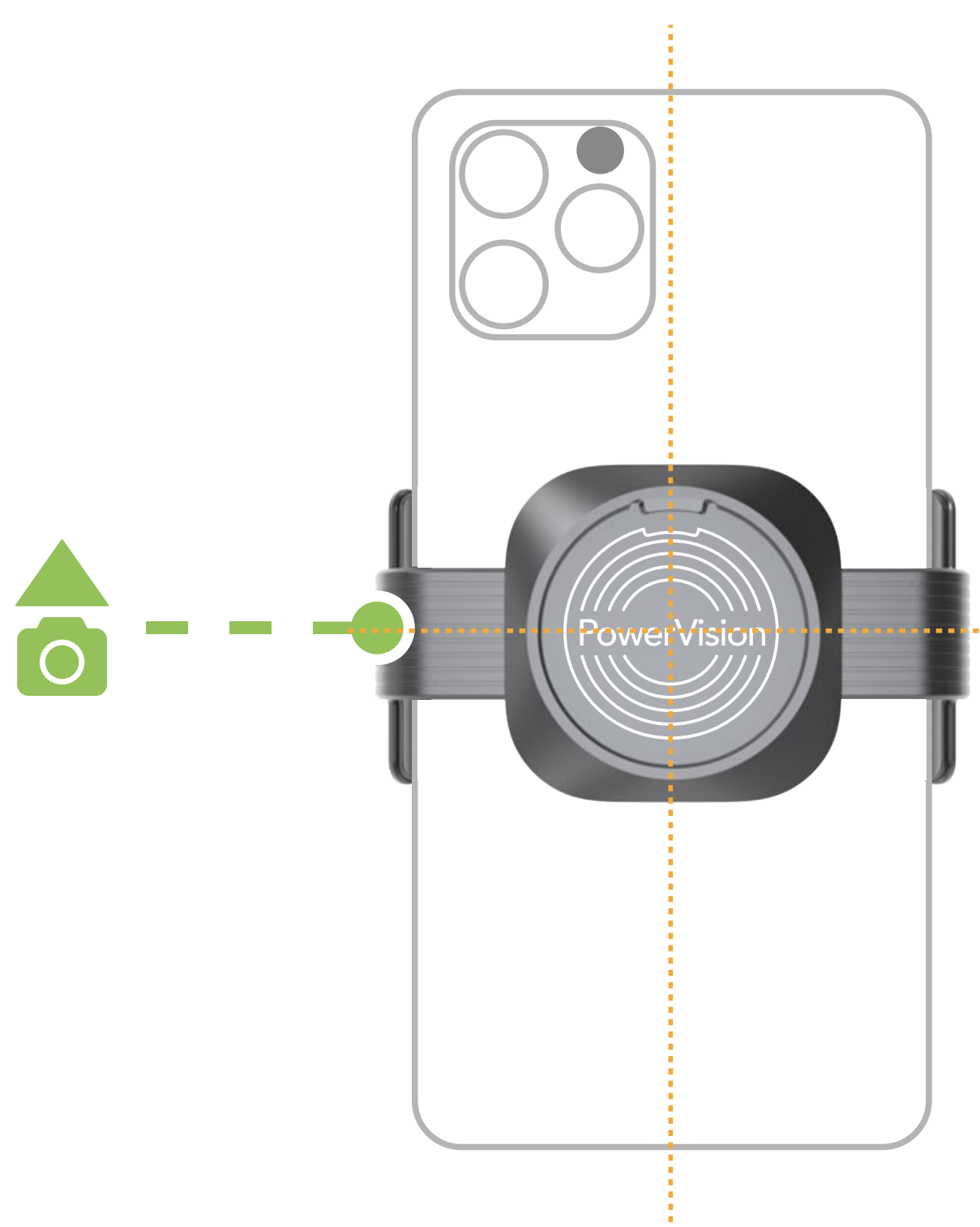

2. Align the magnetic phone clamp with the gimbal's magnetic mounting plate to complete the attachment process.

Note: Ensure that there is no offset in the upper and lower distances of the phone clamp, or this will impact the center of gravity balance when you shoot with the gimbal.

◆ Magnetic phone case

1. Select a magnetic phone case that matches your phone model, align the area with a circle logo with the gimbal's magnetic mounting plate to complete the attachment process.

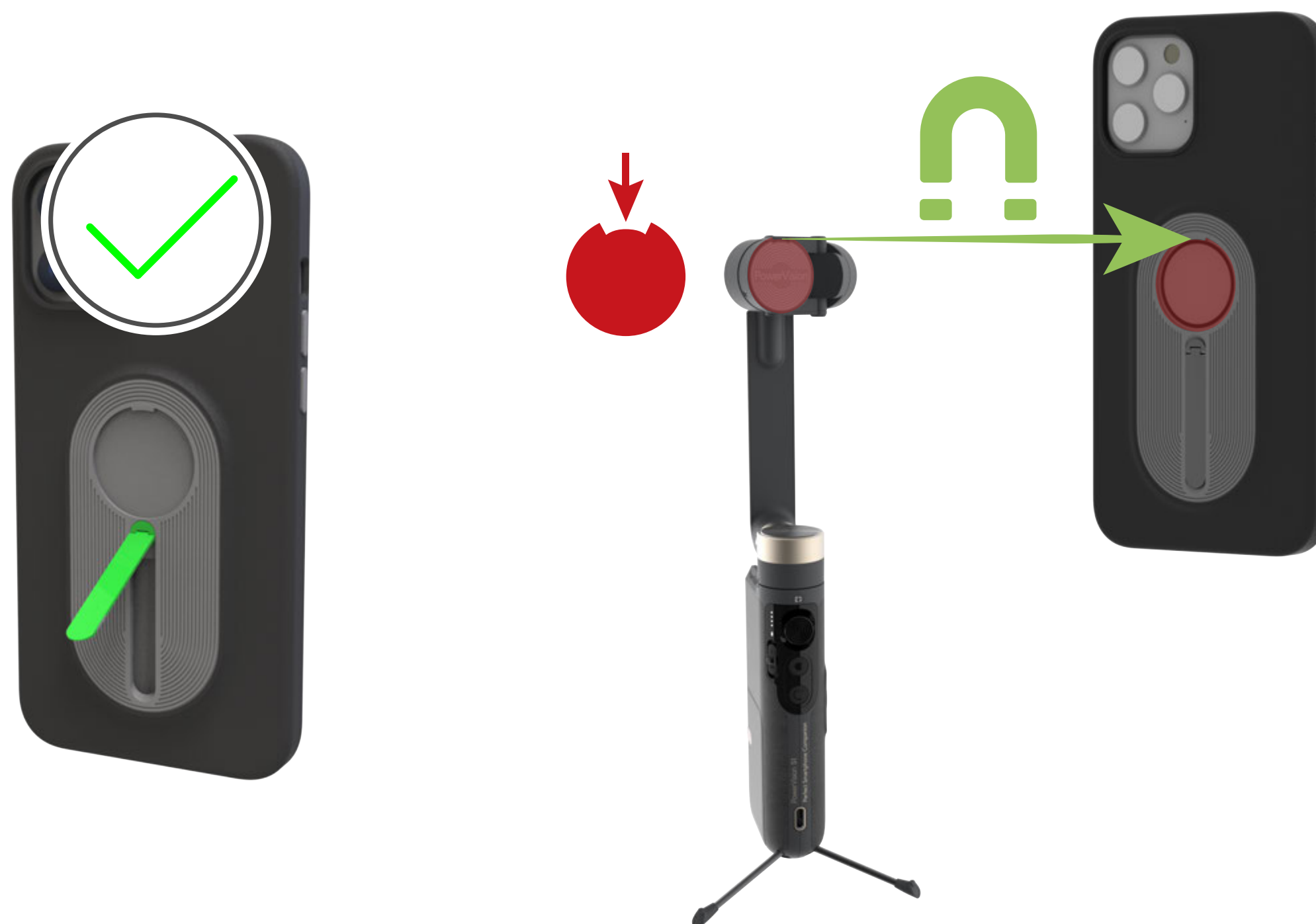

Note: For a list of phone models that are compatible with the magnetic phone case, check details in our official website, www.powervision.me.

◆ Magnetic Universal Phone Mount



For phones that are not included on the list of devices compatible with magnetic phone cases, a magnetic universal phone mount offers rapid installation. To attach a magnetic universal phone mount to the back of your phone, follow these steps:

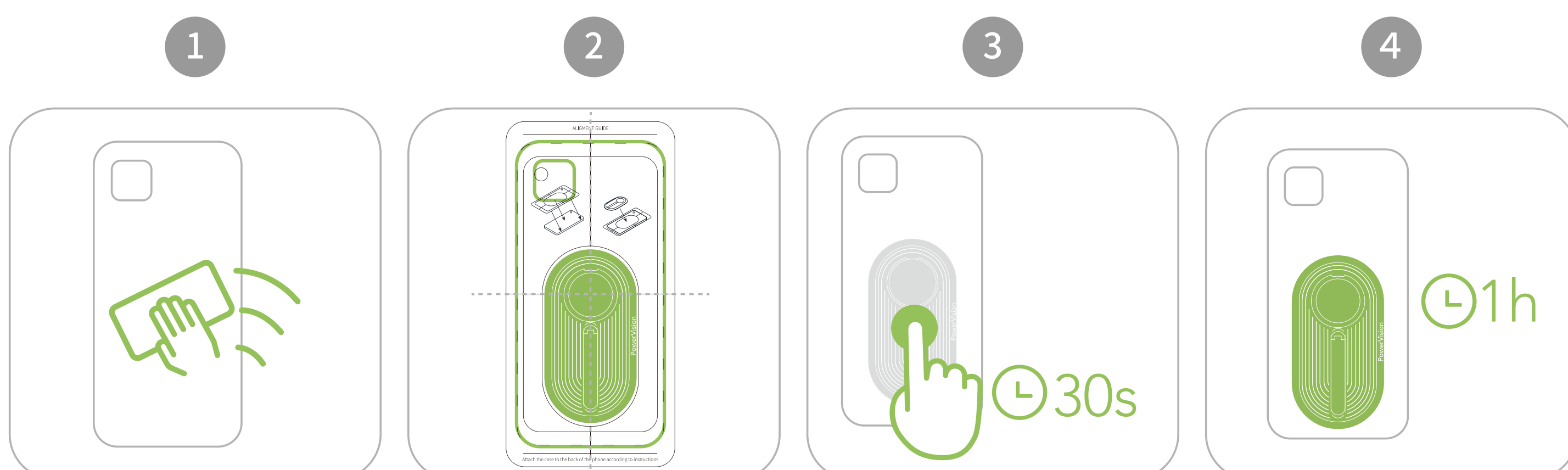

(1) Clean the back of the phone.

(2) Align the center positioning card with the back of your phone, and the magnetic universal phone mount's circular magnetic area with the center of the back of the phone.

(3) Apply pressure to the attached magnetic universal phone mount for 30 s and ensure that it is flat.

(4) Remove the center positioning card and wait for one hour before using the gimbal.

Align the circular logo area with the gimbal's magnetic mounting plate to complete the attachment process.

 A magnetic universal phone mount cannot be attached to the phone case, or it may impact the gimbal's functionality and the phone's wireless charging function.

 If the magnetic universal phone mount is not properly aligned with the phone's wireless charging output, the phone may be unable to use the wireless charging function.





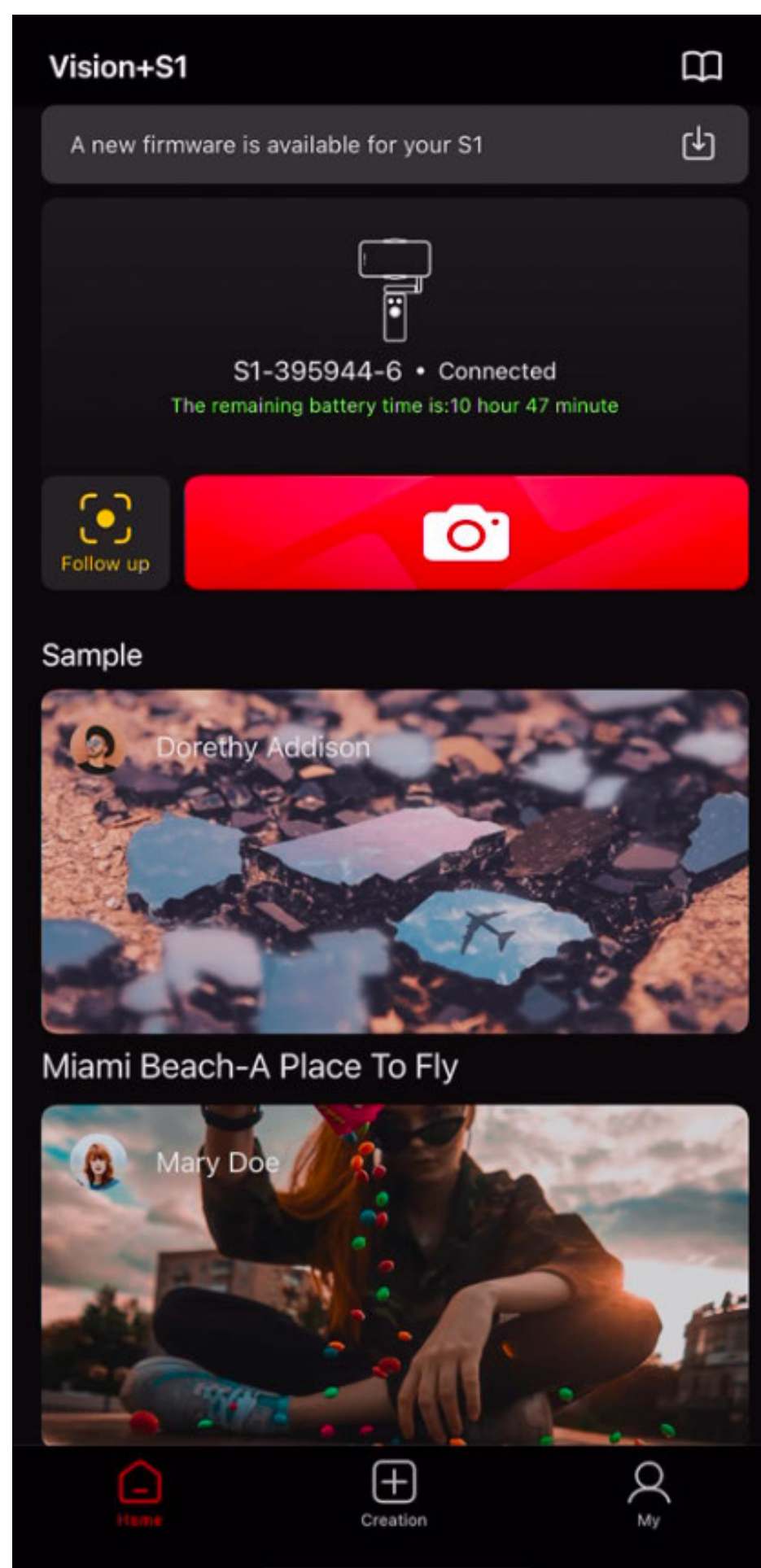

 The magnetic universal phone mount is a disposable product and cannot be used repeatedly.

Preparing for use

PowerVision S1 can be used with its dedicated App. Use PowerVision S1 buttons to activate Camera, Gimbal, Panorama, Motionlapse, and Tracking modes.

Follow these steps to access Vision+S1 App's main functions:



-  Home: View device connection status and the gimbal's remaining battery level.
-  Camera: After connecting with PowerVision S1, enter the camera shooting screen.
-  PowerFollow: After connecting with PowerVision S1, use the PowerFollow function. Then the gimbal will follow your movement during livestreaming.
-  Creation: Tap to enter. This mode allows you to edit the videos you have shot.
-  My Login: Register and log in to your PowerVision account to enter the App settings menu.
-  Help: Tap to enter. View tutorial video and help documents.

Connecting PowerVision S1

Power on PowerVision S1.

Turn on Bluetooth on your phone. Using PowerVision S1 App, select S1 as the name of the device to connect to.

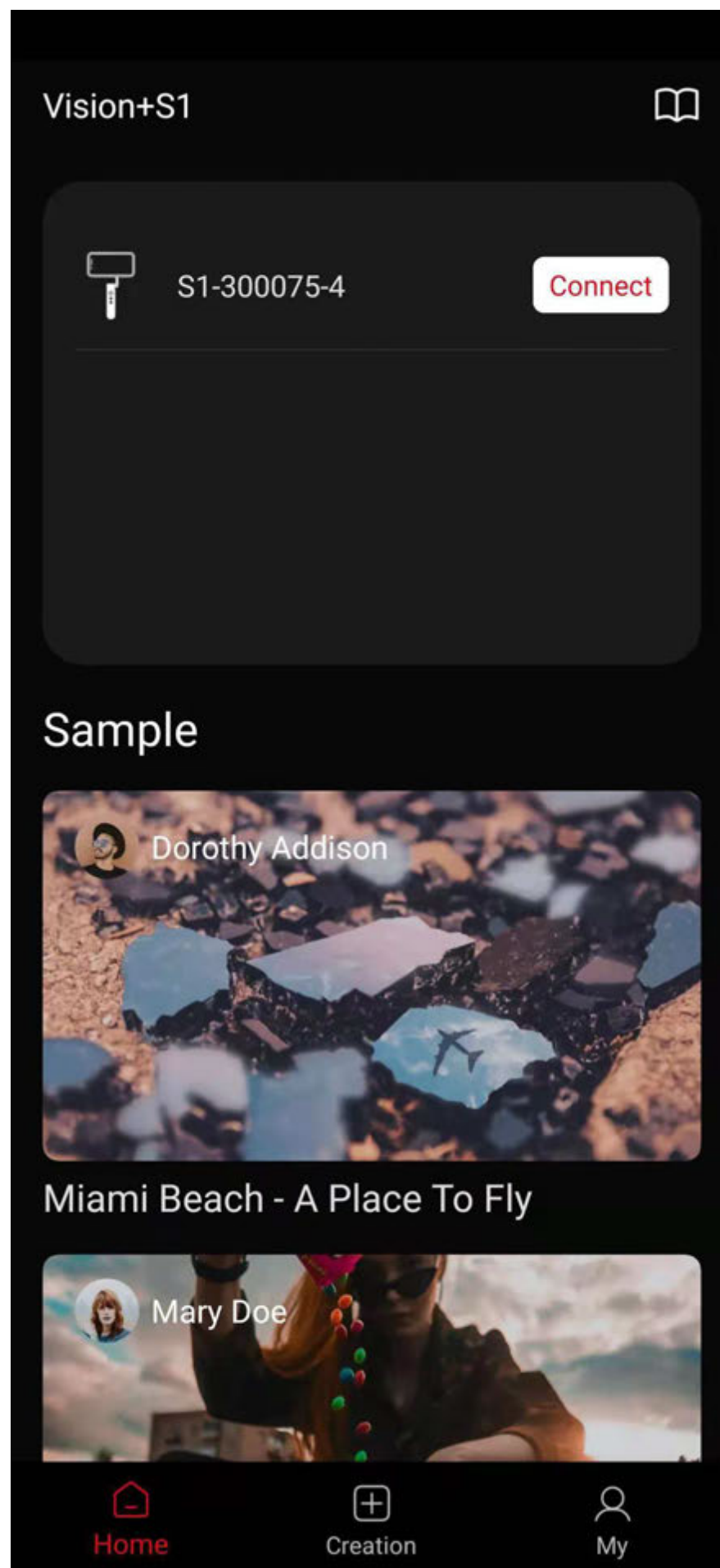

Activating PowerVision S1

The first time you connect to PowerVision S1 you will need to activate your device or you will be unable to use Vision+S1 App functions.

Activating PowerVision S1 requires registering and logging in to a PowerVision account. Completing these steps requires an internet connection.

After completing activation, you can shoot using PowerVision S1 App.

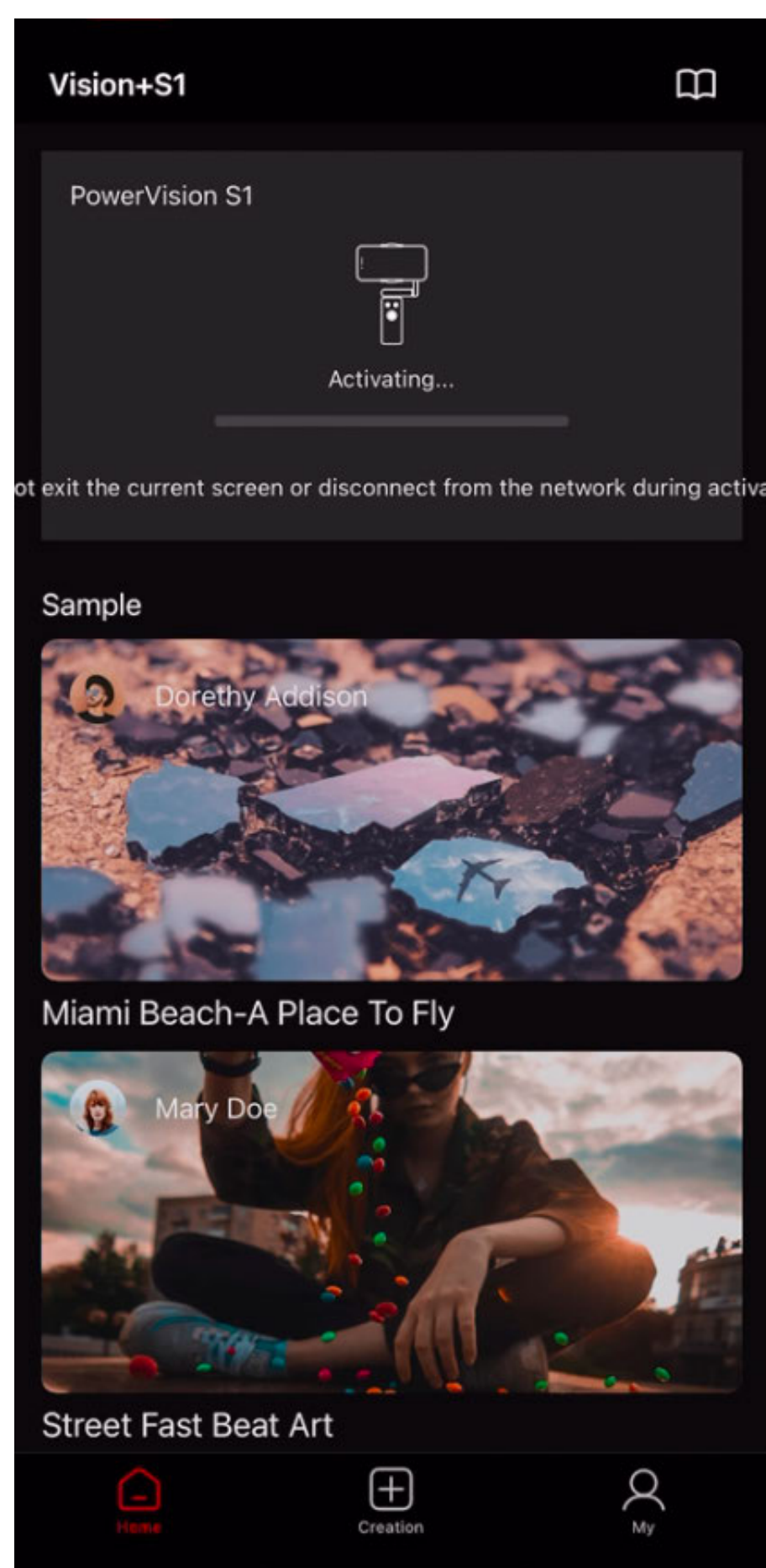

Using the gimbal

I Operating modes

S1 has three operating modes, which can be used in both portrait and landscape shooting modes. The figures below show a phone being used in landscape mode.

◆ Upright Mode

After you unfold S1 and install your phone, hold the device and the device should be positioned beneath the gimbal. Then it is in the upright mode. Press the 5-Way button twice to re-center the gimbal.



◆ Underslung Mode

Underslung mode is an inversion of upright mode. Hold the device and the device should be positioned above the gimbal. Then it is in the underslung mode. Press the 5-Way button twice to re-center the gimbal.



◆ Side Grip Mode

In upright mode, rotate S1 90 degrees to the left or right. Then hold the device and the device should be at a horizontally level with the gimbal. Then it is in side grip mode. Press the 5-Way button twice to re-center the gimbal.

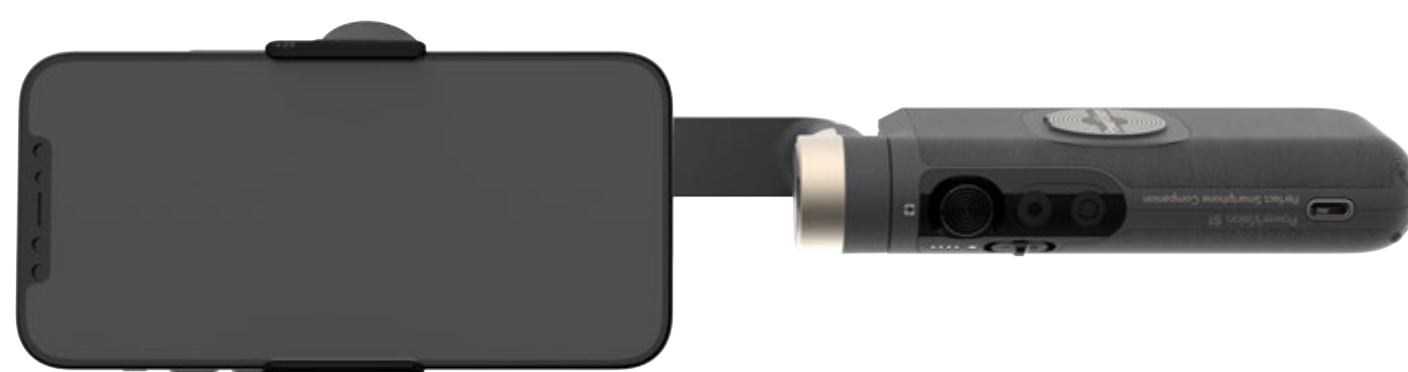

Shoot with Vision+S1 App

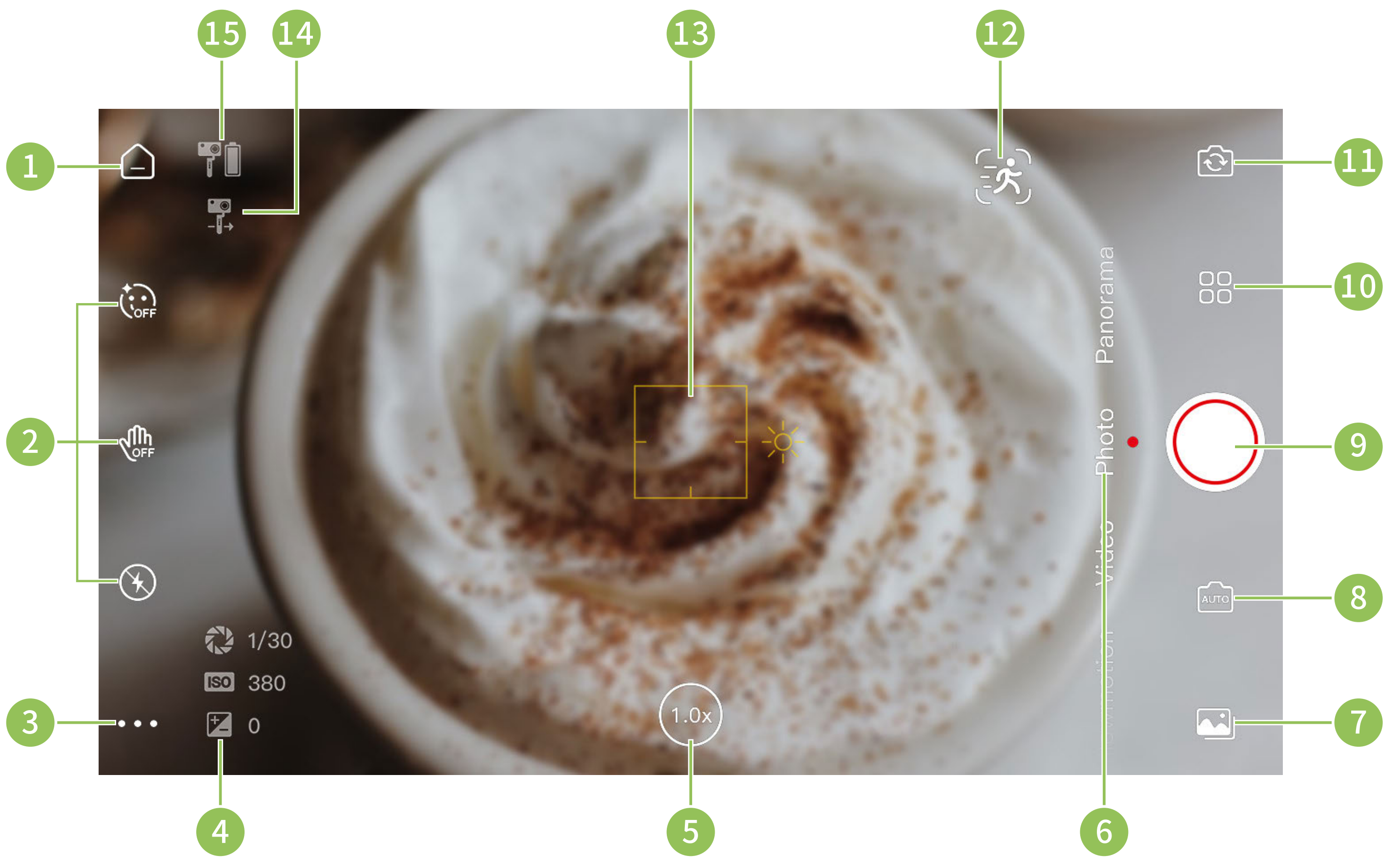

1. Home

 : Press to return to the home page.

2. Camera Status Bar

Shooting Mode	Configurable Parameters
Timewrap	Flash, resolution, frame rate
Timelapse	Flash, resolution and frame rate
Slowmotion	Flash, frame rate
Video	Flash, gesture control, beautify
Photo	Flash, gesture control, beautify
Panorama	Flash, gesture control, timer, Panorama mode

 : Gesture control switch

There are three types of gesture controls when this switch is enabled.

 : Enable or disable Follow

 : Take a photo

 : Start or stop video recording

3. Settings •••

 : Gimbal settings

a. Follow Mode

1) .Follow: The roll axis is locked, and the tilt axis and the yaw axis follow the movements of the device.

2) .Tilt Locked: The roll axis and the tilt axis are locked, and the yaw axis follows the movements of the device.

3) .FPV: The roll, tilt, and yaw axes all follow the movements of the device.

b. Sport Mode Switch: Enables and disables sport mode. When this switch is enabled,

the follow speed increases.

c.Zoom Speed: Controls the zoom speed of the zoom slider.

d.Handle Speed: Adjust the control speed of 5-Way button

e.Horizontal Reverse Switch: When this switch is enabled, if you push the handle left or right, the gimbal's yaw axis will move in the opposite direction of your actual movements.

f.Vertical Reverse Switch: When this switch is enabled, if you push the handle up or down, the gimbal's tilt axis will move in the opposite direction of your actual movements.

g.Gimbal Auto Calibration: When the gimbal encounters unexpected horizontal skewing or drifting, this function automatically recalibrates the gimbal.

h.Gimbal Fine-tuning: This function allows the gimbal's horizontal level to be fine-tuned.

 : General Settings

Manage current connection settings and view setting names, firmware version, and device serial number, etc.

4、Exposure Parameters

   : Real-time display of the current shutter speed, ISO and EV values.

5、Zoom

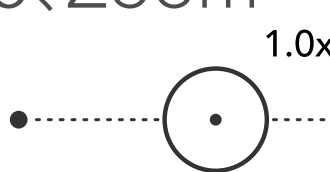
 : Shows the current zoom ratio. Use the zoom function to zoom in or out.

6、Shooting Mode

Swipe to choose different shooting modes

Timewrap: The phone shoots a time-lapse while in motion.

Timelapse: Includes normal time-lapse and Motionlapse. A normal time-lapse requires setting the time interval and length of time. For Motionlapse, you can also set up to 4 gimbal positions.

Slowmotion: Chooses a frame rate to shoot in slow motion.

Video: Shoots regular video.

Photo: Takes photos.

Panorama: Uses the gimbal to automatically shoot a panoramic photo. Supports 3*3, 240°, and clone modes.

7、Media Library

 : View local media library resources.

8、Exposure Parameter Settings

 : Adjust exposure parameters.

9、Camera Button

 : Press to start or stop shooting.

10、Shortcut Function Menu

 : Different shooting modes have different parameter. Visit the App shooting page for more details.

11、Front/Rear Camera Switch

 : Press to switch between the front and rear cameras

12、Tracking Mode

 : Tracking mode helps you to keep your target in the center position in the

frame while photographing or recording. Tracking mode can be enabled using three methods:

- a. Short press the 5-Way button and PowerVision S1 will automatically start tracking the object in the center of the frame. Press the 5-Way button again to deactivate object tracking.
- b. Manually draw a box on the screen to choose an object to be tracked. Press the tracking icon to deactivate object tracking.
- c. Enable gesture recognition in the status bar of the shooting page. Show the camera lens with the "Five" gesture and the system will automatically recognize the object and start tracking it. To deactivate object tracking, make the same gestures towards the camera lens.

13. Focus Frame

 : Focus frame

14. Gimbal Battery Level

 : Shows the gimbal's current battery level.

15. Gimbal Mode

 : Shows the current gimbal mode.

Note: Camera setting functions may differ depending upon the phone model you are using. Actual supported functions may vary.

Using PowerFollow Mode

PowerVision S1 features a unique and innovative follow-up function that enables PowerFollow mode. This mode can be enabled to perform automatic tracking when you use PowerVision S1 as a phone stand. PowerFollow is useful when you use third party applications such as livestreaming and video calling Apps. When PowerFollow mode is enabled, S1 will activate inspection and recognition of the portrait that appears within the phone screen, using algorithms to analyze portrait movement and control the gimbal's rotations, effectively locking onto the target.



The PowerFollow function can be used with the front or rear cameras of your phone. When using different camera lenses, the gimbal will use a different default tracking direction.

The pan tracking angle range is 260 degrees. The tilt tracking angle range is -20 to 20 degrees.

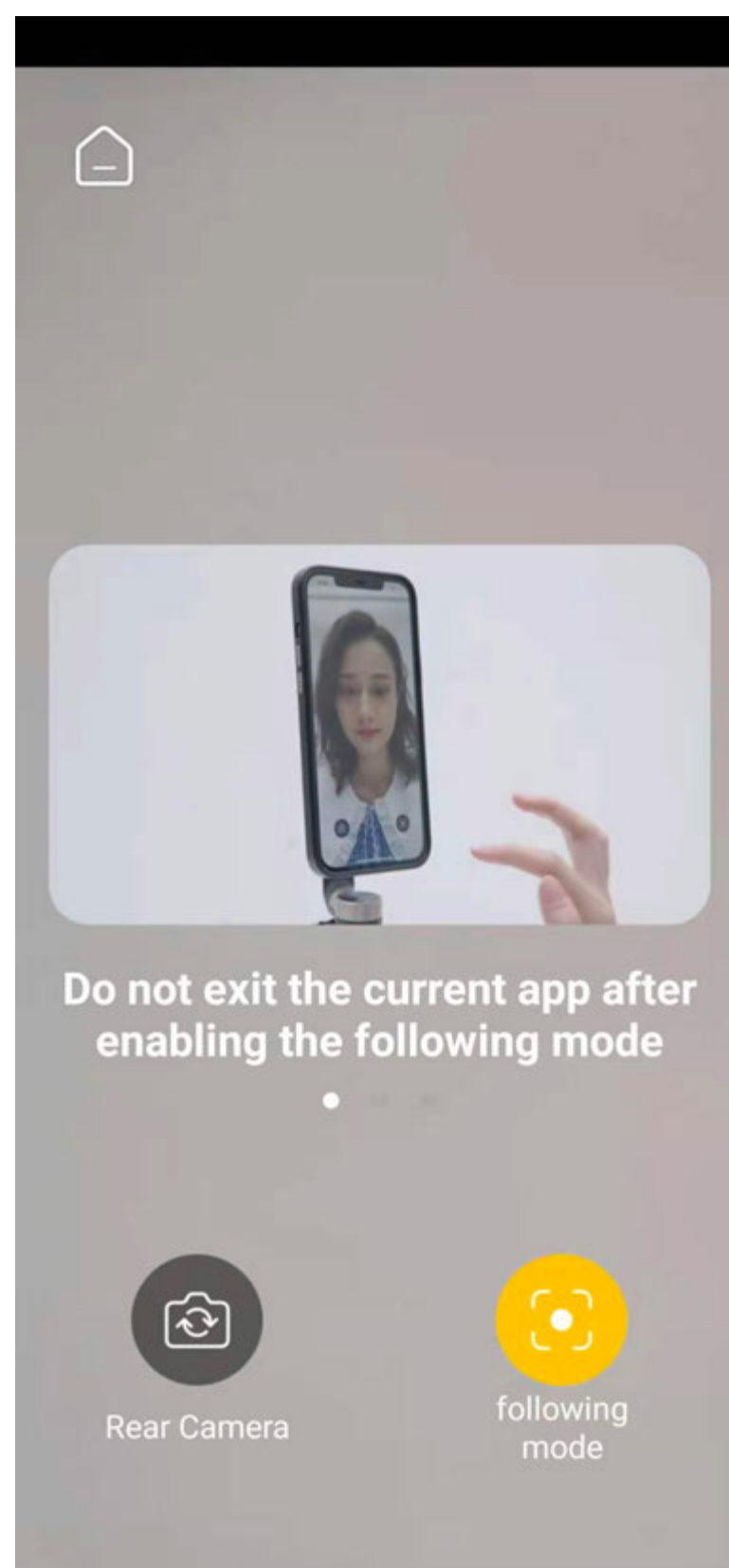

Procedure:

1. Set PowerVision S1 on a level surface, turn on the device, and connect to the App.
2. Enable the PowerFollow function in the App.
3. Open the third party livestreaming platform and activate tracking with a gesture or by pressing the camera button on the gimbal. Activate subject tracking using gestures .



Activate/Stop subject tracking by pressing the camera button  on the gimbal.

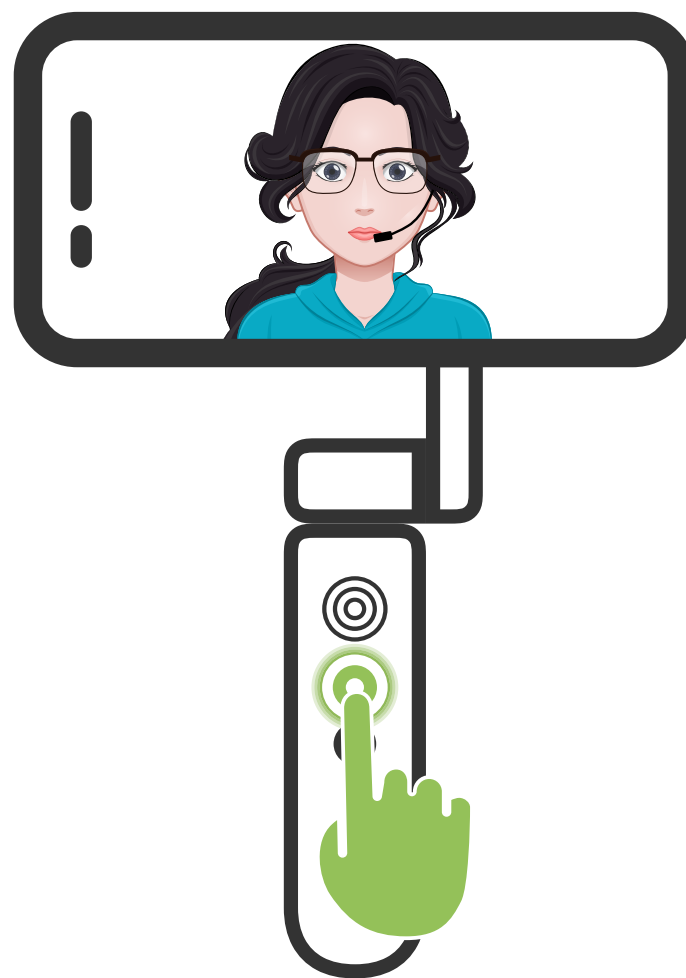

To stop tracking, adjust the directional buttons or press the 5-Way button twice during the tracking process.

Charging Smartphone with S1

PowerVision S1's built-in 4120 mAh battery can charge phones using a cable or wirelessly. When S1 is powered off, it can wirelessly charge at a charging power of up to 10 W, or up to 18 W with a wired charger. When S1 is powered on, S1 supports a maximum charging power of 5 W. Note that only wired charger mode is supported when S1 is powered on. Using a magnetic phone case or magnetic universal phone mount will increase wireless charging accuracy and efficiency, because it assists wireless charging in precise alignment.



1. Wireless charging power is determined by battery levels, wireless contact distance, phone model, and other factors. Actual results may vary.

2. For a list of phone models which support wireless charging using S1, visit our official website: www.powervision.me.

Charging your phone wirelessly

Steps for charging your phone equipped with a magnetic phone case or magnetic phone stand are described as follows:

1. Adjust the slide stand of the magnetic phone case and set the phone case to wireless charger mode.
2. Keep S1 in folded and OFF mode, and move your phone close to the wireless charging output on S1. It will automatically attach.
3. Short press S1 Power button to start charging. The system status indicator will turn solid orange, and your phone will display a charging symbol.



1. To stop charging, detach the phone from the S1 or turn on S1 during the charging process.

2. To charge your phone wirelessly without using a magnetic phone case, align the center of the phone with wireless charging output of S1. If your phone does not charge normally, adjust the phone's position until it displays a normal charging symbol.

Functions as a wireless charger for phones

PowerVision S1 can connect to a USB charger and function as a wireless charger for other devices, charging both your phone and S1 at the same time.



Charging your phone with a wired charger

Procedure

1. Connect your phone to S1 using a USB cable.
2. Press S1 Power button to start charging.



1. When the S1 is powered on, it only supports charging with a wired charger, at a maximum power of 5 W.
2. When both wireless and wired charging are activated at the same time, only wired charging will be used.

Firmware Upgrade

S1 can be updated on the App. Updating takes about 3 minutes.

Before updating, check that the S1 battery level indicator has at least 2 illuminated bars. Connect S1 to the App. If the App notifies you that there is a new firmware version available for download, you can tap to start the firmware update.

Do not exit the App screen or start other background operations while upgrading the firmware. Please follow the prompts to complete the process. During the update process the system status indicator will blink blue.

After the firmware has been updated, S1 will restart automatically.

If the update fails, please follow the App prompts to try again. If the firmware update is still failed after multiple attempts, please contact after-sales services.

Specifications

PowerVision S1	
Folded Dimensions	141.5 × 58.4 × 27.9mm
Unfolded Dimensions	258.5 × 58.4 × 59.3mm
Weight	298g
Compatible Payload Weight	220±60g
Compatible Phones Length	164mm Max.
Battery	
Type	Li-ion
Energy	15.86Wh/1030mAh 15.4V *Capacity equal to 4120 mAh 3.85V
Max Working Time	15 hrs * Under ideal conditions with the gimbal fully balanced.
Charging Time	2hrs * Measured with a 18W charger.
Working Temperature	0 - 40 °C
Charging Temperature	5 - 40 °C
Max Charging Power	18W, 5V/3A 9V/2A 12V/1.5A
Charging Output	
Wireless Output	10W Max.
USB-C Output	PowerOff: 18W Max. PowerOn: 5W Max.
Wireless	
Model	BLE 5.0

PowerVision

※ This content is subject to change without prior notice.
Download the latest version from <https://www.powervision.me/>
PowerVision is the trademark owned by Powervision Tech Inc.
Copyright © 2021 Powervision Tech Inc. All rights reserved.